

POOL ASSEMBLY AND INSTALLATION INSTRUCTIONS



ROUND POOLS

THINK "SAFETY FIRST" Safe and correct use of your new Doughboy pool means swimming and wading only. DO NOT DIVE OR JUMP!

INSTALLATION Installation of a Doughboy pool is not very hard, but it is a big job. The job will be easier if two or three friends help with the installation.

LOCAL CODES Check to see if building permits or utility clearances are required (for example - National BOCA Code requires the pool to be a minimum of six feet from the property line and a minimum of ten feet from the street).

SPECIAL CARE Doughboy pools are designed to exceed industry recommended safety factors. However, special care must be taken with certain installation procedures that the installer performs and controls.

CONTRACT INSTALLATION Doughboy Recreational is in no way affiliated with any professional pool installer. Therefore, Doughboy can assume no responsibility for errors in installation by the homeowner or said professional installer.

DO NOT BACK-FILL AGAINST POOL WALL Back-filling against the pool wall can cause outside ground forces to collapse the pool.

DO NOT BURY POOL Burying a pool in the ground above the bottom rails will cause aggressive soils to corrode the pool components.

PROVIDE GOOD DRAINAGE Prevent run-off rain water and general yard watering from settling against the pool frame and wall to prevent corrosion and unsightly crustation build-up on the pool components.

WALL WRINKLING Prevent wrinkling of the pool wall during installation by checking and rechecking the levelness of the ground and patio blocks (Optional) at each vertical (Step 3).

TILTED POOL If the ground level slopes in any direction more than 1" from one side to the other or 1" from one end to the other, the wall may rupture causing extensive property damage and personal injury.

POOL LAYOUT DIMENSIONS

Numbers across the top represent the various diameters of Doughboy above ground family pools. Below each size is a layout of that pool showing the diameter indicated by a solid line and clearance radius is shown (see Step 1) which is required for external pool parts.

IMPORTANT INSTALLATION NOTE: Pool sizes noted above each diagram are "nominal" sizes only. Refer to the actual pool wall radius if you are installing an optional concrete footing prior to pool assembly.

CAUTION: When installing an optional concrete footing or deck under the pool and/or pool wall, you still must install pool coving as detailed in Step 12. Omitting the coving will allow the liner to be pushed under the pool wall, leading to pool failure.

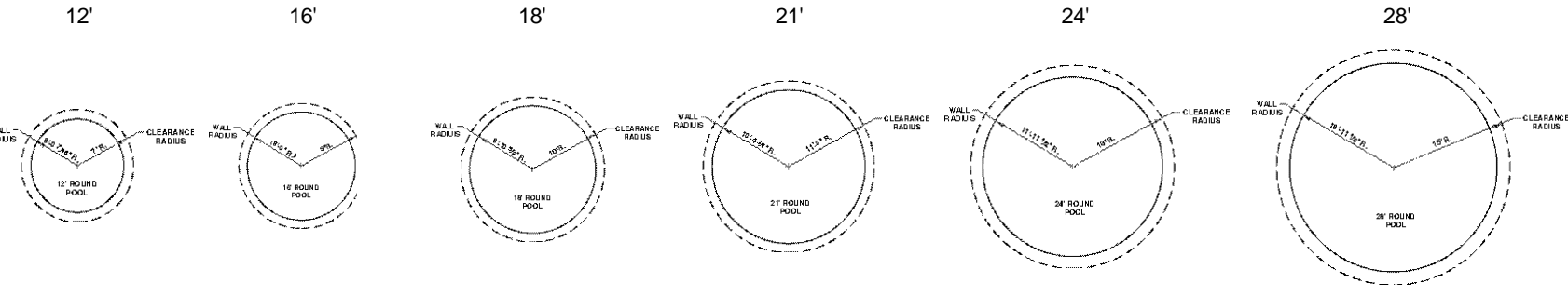

INSTALLATION CAUTIONS

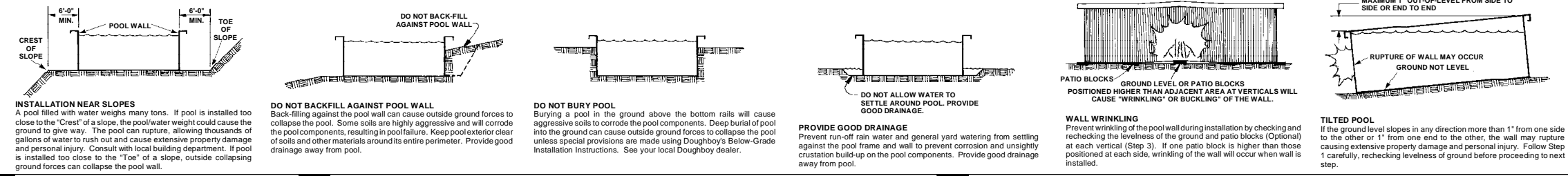

1) Framework must be level - Referring to "Installation Cautions" shown at right, six pool installations illustrate improper methods of installation or errors during the leveling of the ground (Step 1) or positioning of the patio blocks (Step 3).

2) Wall joint and joint piece - This is where the wall joints together. Damage to the wall joint or joint piece reduces the safety factor and can result in a weak installation. Follow instructions using extreme care.

3) Cove - The cove keeps the liner from creeping out from under the pool wall. Follow instructions to the letter. Don't short-cut or substitute materials. Do not use materials that will shift. Improperly installed pools can rupture, allowing thousands of gallons of water to rush out and cause extensive property damage and personal injury.

4) Set up pool on soil surface. Doughboy pools are not designed to be installed below-grade (buried) using these instructions. Outside ground forces can collapse the pool wall. For approved Below-Grade Installation Instructions, see your Doughboy dealer.

HOW TO USE THESE INSTRUCTIONS These installation instructions are used in conjunction with your pool parts list for identifying parts as referred to in each step. Your pool can be excavated for a deep swimming area if the liner carton is labeled 20 Mil. or 25 Mil. expandable (see Step 2).

PRELIMINARY PLANNING Refer to POOL LAYOUT DIMENSIONS above for your pool diameter. Drive stake into ground at pool center. With a shovel and the constructed depth leveling tool shown above, remove sod and level pool area.

20 MIL. STRETCH-IN LINERS OR THICKER ONLY - Using the center stake as your reference point, lay out and excavate area to the dimensions shown in the above chart for your pool diameter. Remember: DO NOT DIVE OR JUMP into the pool. The excavation is intended to provide a deeper and wider swimming area only.

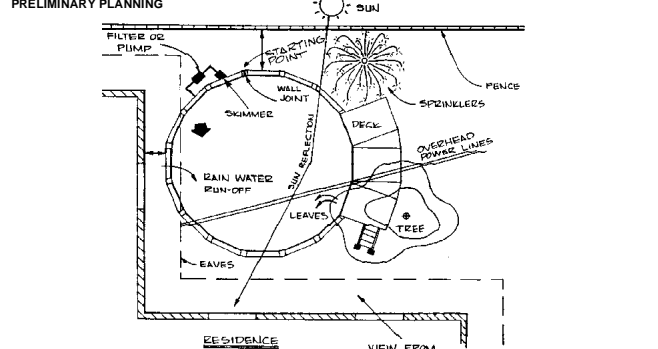

IMPORTANT: Before beginning your pool installation, take a few minutes to consider the following points:

- 1. Check wall clearances to allow enough working area for your pool installation.
2. Check for easements.
3. Avoid trees and roots; do not allow leaves to fall into the pool.
4. Avoid overhead power lines.
5. Avoid underground piping and cables.
6. Keep sprinklers away from pool sides.
7. Select a pool site that allows for the proper supervision of swimmers as well as viewing children near the pool.
8. Position the pump and filter near convenient electrical outlets.
9. Avoid overhanging eaves to prevent water and debris runoff from your roof.
10. Allow 12 inches of undisturbed soil around your pool (clearance radius).

TOOLS AND MATERIALS REQUIRED

- Materials Needed -
• Nails - 2 1/2" Long (1 Doz.)
• 12" x 12" x 2" patio blocks (Optional) - one per vertical
• Ball of heavy string
• Binder clips - 1 1/4" - 2" size (Available at stationary supply stores) - two per top rail
• 2" x 4" board (See Step 1 for length)
• Duct tape (2" wide)
• Wood stake - 2" x 2" x 18"
• Pool coving (See Step 12)
• Enamel, fast drying (not lacquer)
• 2" Carpenter's level (Transit recommended)
• Hammer
• Flat end shovel
• 5/16" Hex nut driver
• 25" Tape measure
• Garden rake
• Tamping tool
• Roller (if available)
• Screwdriver, flat end (Large)
• 2 or 3 Garden hoses (Fill pool)
• Felt tip marking pen
• Carpenter's saw
• Sifting screen (To remove 1/8" pebbles and larger)
• Sharp knife or single edge razor blade
• Drill/Bit (See Step 1)
• Small paint applicator ("Q-Tip", cotton ball or match stick)

POOL FASTENER IDENTIFICATION

Your pool assembly may not require all the fasteners shown below. Refer to your Pool Parts list for the fasteners required to assemble your pool.

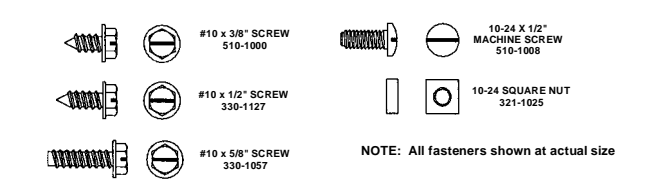

1 POOL LAYOUT & GROUND LEVELING

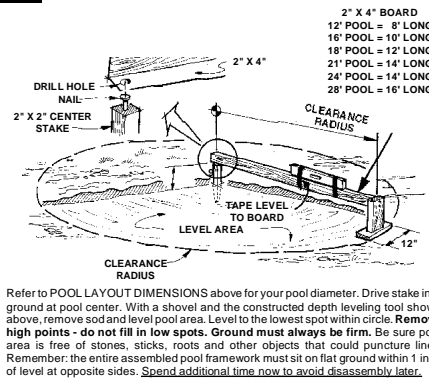

2 OPTIONAL SPECIAL PURPOSE DEEP SWIMMING AREA ONLY

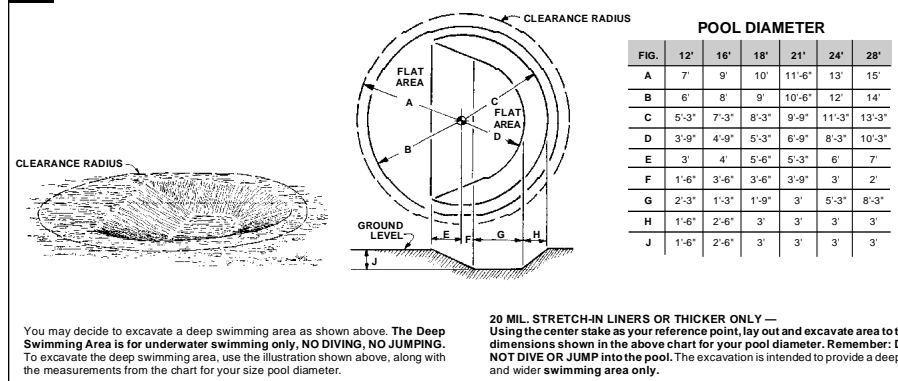

3 POOL RADIUS LAYOUT

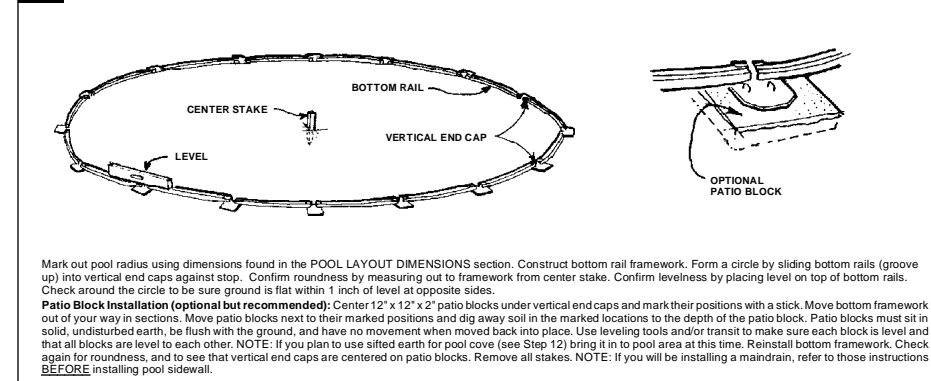

4 INSTALL WALL

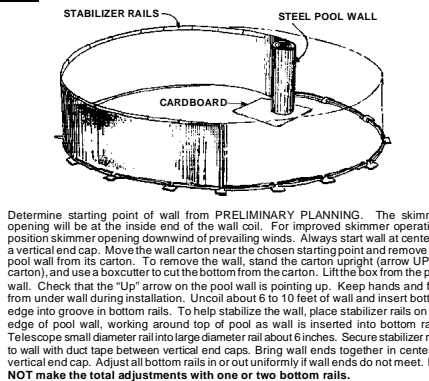

5 INSTALL WALL JOINT

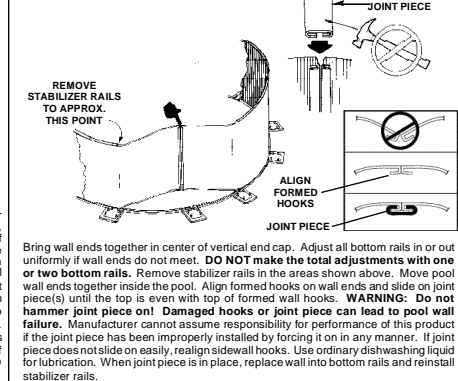

COAT OPENINGS

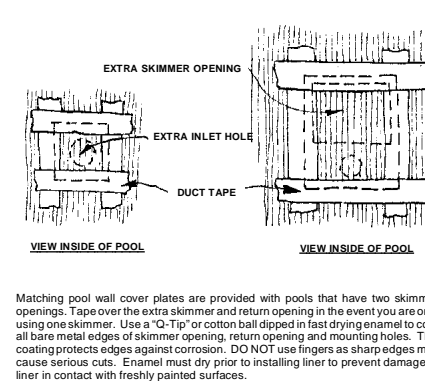

INSTALL VERTICALS

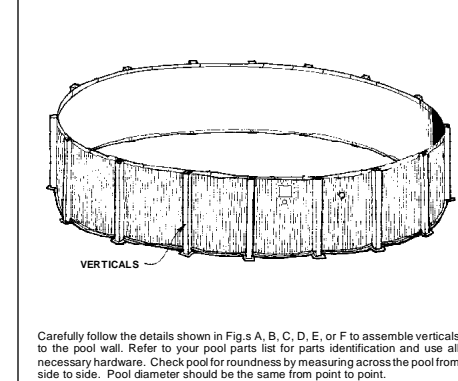

6" & 6-1/2" TOP RAILS

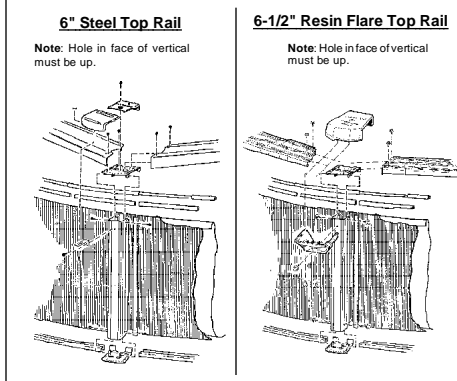

6" FLARE TOP RAIL

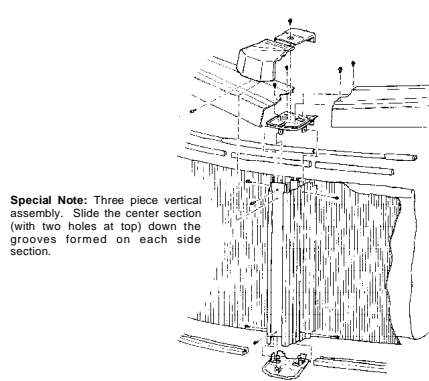

7" FLARE TOP RAIL

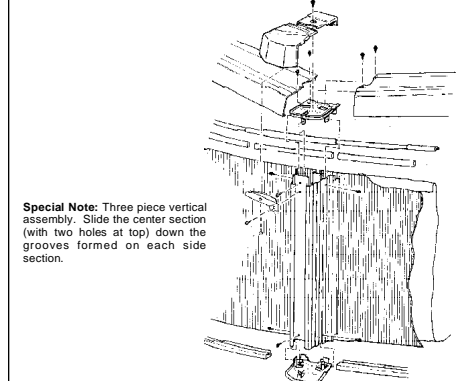

8" RESIN

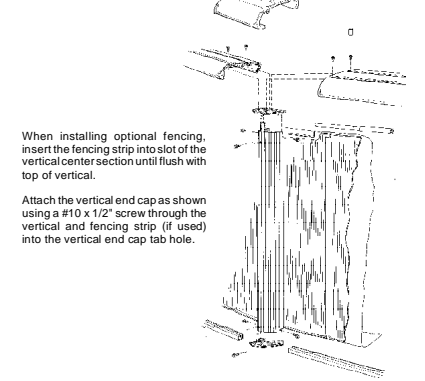

8-1/2" CLASSIC TOP RAIL

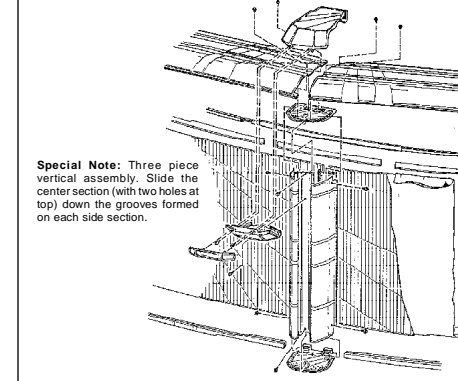

10-1/2" RESIN TOP RAIL

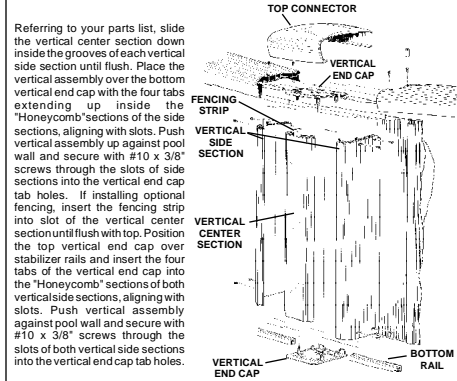

8 ATTACH VERTICAL END CAPS

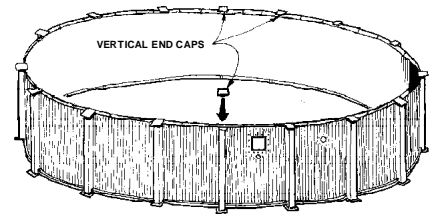

Carefully follow Figures A, B, C, D, E, or F to attach vertical end caps to verticals. Check pool for roundness. Check straightness of verticals using level tool.

9 INSTALL TOP RAILS

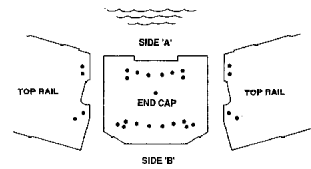

Each pool size has a specific hole pattern for mounting the top rails to the vertical end caps. Use the figure that matches your pool series, size, and the accompanying chart to locate the correct mounting holes.

HELPFUL SUGGESTION: Use a felt pen to mark the proper holes before you assemble the top rails to the vertical end caps.

Use four #10 x 3/8" screws to attach the top rails to the end caps. Insert screws through the proper hole in top rail and screw into the proper hole on end cap. From the chart, select the proper holes (stamped on top rails and end caps).

EXAMPLE - 6" Standard Top Rail Model - 18" Diameter Pool
Screws nearest Side A: Insert screw through hole stamped "C" on top rail, and screw into hole stamped "18" on end cap. **Screws nearest Side B:** Insert screw through hole stamped "18/24" on top rail, and screw into hole stamped "18" on end cap.

NOTE: The 8" & 10-1/2" Top Rail Resin Pool are supplied with a 5/16" magnetic socket for fastening top rails onto vertical end caps - use a 1/4" drive ratchet with 3" extension.

6" STANDARD & 6-1/2" RESIN FLARE POOLS

HOLE CHART FOR 6" STANDARD & 6-1/2" RESIN FLARE TOP RAIL POOLS

HOLE LOCATIONS	POOL DIAMETER							
	12'	16'	18'	21'	24'	28'	28'	28'
RAIL HOLE - SIDE "A"	C	C	C	C	C	C	C	C
END CAP HOLE - SIDE "A"	12	16	18	21	24/28	24/28	24/28	24/28
RAIL HOLE - SIDE "B"	C	C	18/24	C	18/24	C	18/24	C
END CAP HOLE - SIDE "B"	12	16	18	21	24	28	28	28

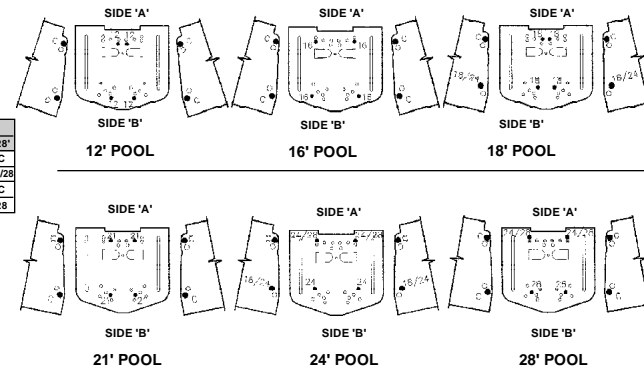

6" & 7" FLARE POOLS

HOLE CHART FOR 6" & 7" FLARE TOP RAIL POOLS

HOLE LOCATIONS	POOL DIAMETER							
	12'	16'	18'	21'	24'	28'	28'	28'
RAIL HOLE - SIDE "A"	C	C	C	C	C	C	C	C
END CAP HOLE - SIDE "A"	12	16	18	21	24/28	24/28	24/28	24/28
RAIL HOLE - SIDE "B"	C	C	C	C	C	C	C	C
END CAP HOLE - SIDE "B"	12	16	18	21	24	28	28	28

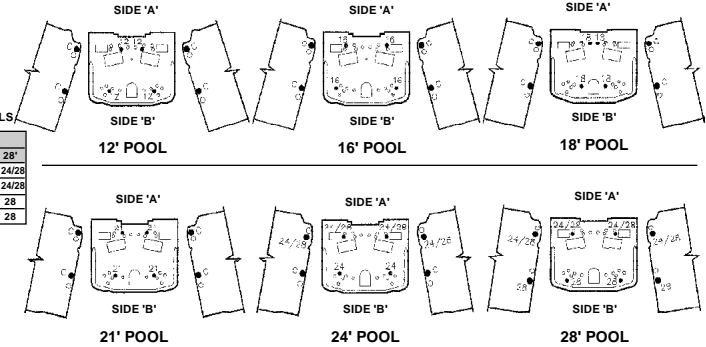

9 cont' INSTALL TOP RAILS

8" RESIN & 8-1/2" CLASSIC POOLS

10-1/2" SIGNATURE SERIES POOLS

HOLE CHART FOR 8" RESIN & 8-1/2" STEEL TOP RAIL POOLS

HOLE LOCATIONS	POOL DIAMETER							
	12'	16'	18'	21'	24'	28'	28'	28'
RAIL HOLE - SIDE "A"	12/16	12/16	C	C	C	C	C	C
END CAP HOLE - SIDE "A"	12	16	18	21	24/28	24/28	24/28	24/28
RAIL HOLE - SIDE "B"	C	C	C	C	C	C	C	C
END CAP HOLE - SIDE "B"	12	16/28	18	21	24	28	28	28

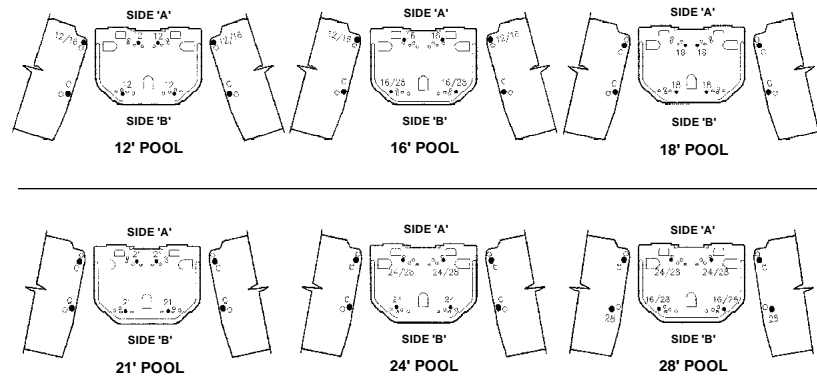

HOLE CHART FOR 10-1/2" RESIN TOP RAIL POOLS

HOLE LOCATIONS	POOL DIAMETER							
	12'	18'	21'	24'	28'	28'	28'	28'
RAIL HOLE - SIDE "A"	5/12/18	C	C	C	C	C	C	C
END CAP HOLE - SIDE "A"	12	18	21	24/28	24/28	24/28	24/28	24/28
RAIL HOLE - SIDE "B"	C	C	C	C	C	C	C	C
END CAP HOLE - SIDE "B"	12/24	18	21	24/24	28/18	28/18	28/18	28/18

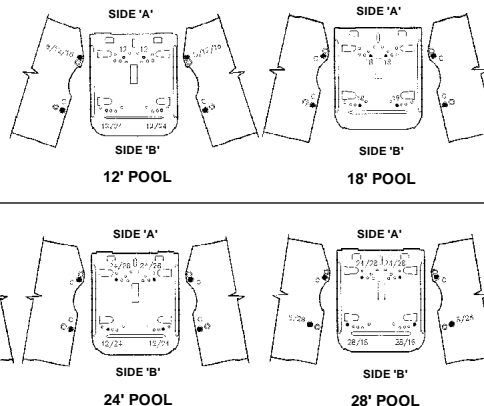

10 RECHECK LEVEL

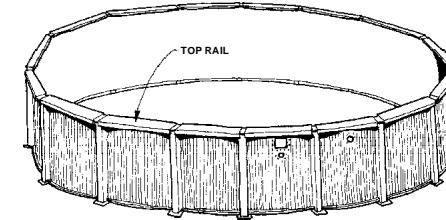

Attach all top rails using the chart from Step 9 to determine proper holes for attachment. At this time it is extremely important to check the framework to assure level installation. Place the level on each top rail, working gradually around pool, to assure framework is on flat ground with opposite sides no more than 1 inch out of level. **Remember: Always remove dirt to adjust framework - never fill in!**

11 ATTACH TOP CONNECTORS

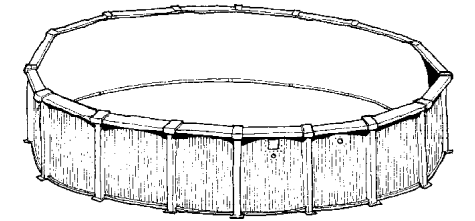

Attach all remaining hardware and brackets shown in the detail of your pool. Refer to Figures A, B, C, D, E, or F to attach top connectors to pool. **For 6" Standard, 6" Flare and 7" Flare steel top rail models:** Attach inside connector first using one #10 x 3/8" screw. The outer connector slides over inner connector. **For 7" flare models only:** Attach the connector skirt to vertical and outer connector using #10 x 3/8" screws. **For 6-1/2" Resin top rail pool models:** Assemble a connector skirt to each vertical using #10 x 1/2" screws. Hook the back of the top connector over inside lip of top rail, then swing it down over end cap aligning the inside locating tab with hole in end cap. Attach the top connector to the skirt with two #10 x 5/8" screws. **For 8-1/2" Classic models:** Attach connector skirt to vertical using one #10 x 3/8" screw. Hook rear of top connector under inside lip of top rail and swing down over end cap to align with connector skirt. Attach with two #10 x 3/8" screws. Install the connector's decorative strip. **For 8" & 10-1/2" Resin models:** Hook the back of the top connector over inside lip of top rail then swing down over end cap and hook over outside lip of top rail.

12 COVE

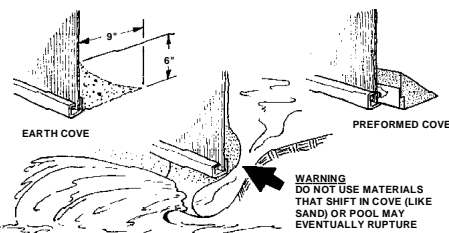

Important Step: The cove is a vital structural element that prevents water pressure from forcing the pool liner out under the bottom rail. The manufacturer will not assume responsibility should the cove be omitted.
EARTH COVE: Use screened damp earth to form a cove around the inside base of pool wall. Shape and compact firmly.
PRE-FORMED: Specifically designed pre-formed pool cove is available from your dealer. Follow cove manufacturer's instructions. **Recheck pool for roundness after installing cove.**

13 LINER SEAM POSITIONING

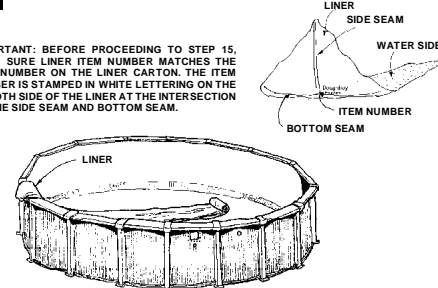

IMPORTANT: BEFORE PROCEEDING TO STEP 15, MAKE SURE LINER ITEM NUMBER MATCHES THE ITEM NUMBER ON THE LINER CARTON. THE ITEM NUMBER IS STAMPED IN WHITE LETTERING ON THE SMOOTH SIDE OF THE LINER AT THE INTERSECTION OF THE SIDE SEAM AND BOTTOM SEAM.
 Check the pool floor (area inside pool wall) for levelness. Fill in all slight depressions with sifted earth and tamp. Remove all stones and sharp objects. Fill in all footprints on pool floor. **NOTE: If you intend to install an E-Z Clip Liner, follow the instructions packed with it at this time and disregard steps 14 through 19 on this sheet.** Place liner on top of top rail. The liner should have the loose end overhanging the outside of pool by about 12 inches. Hold end and unroll liner down middle of pool as you would a carpet. Do not place liner side seam over skimmer or return fitting opening. The center seam of the liner must be positioned at the center line of the pool on 12, 21 and 24-foot round pools. For 16, 18 and 28-foot round pools, position the center liner section (not the seam) at the center line of the pool. **NOTE: The embossed side of the liner will be the water side.**

14 LINER SEAM POSITIONING FOR EXCAVATED POOLS ONLY (Stretch-in Liners)

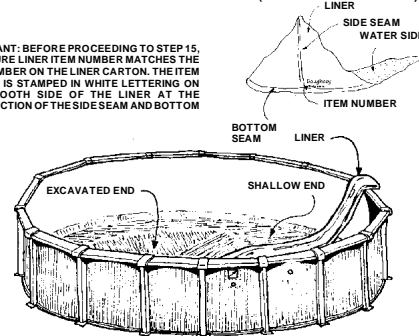

IMPORTANT: BEFORE PROCEEDING TO STEP 15, MAKE SURE LINER ITEM NUMBER MATCHES THE ITEM NUMBER ON THE LINER CARTON. THE ITEM NUMBER IS STAMPED IN WHITE LETTERING ON THE SMOOTH SIDE OF THE LINER AT THE INTERSECTION OF THE SIDE SEAM AND BOTTOM SEAM.
 Check fitness of tapered area with 2" x 4" board. Fill in all slight depressions with sifted earth and tamp. Remove all stones and sharp objects. Fill in all footprints on pool floor. Place liner on top of middle top rail at the shallow end of pool. The liner should have the loose end overhanging the outside of pool by about 12 inches. Hold end and unroll down middle of pool into deep end. The center seam or center section of the liner must begin at the shallow end and run along the center line of the pool to the deep end.

15 INSTALL LINER

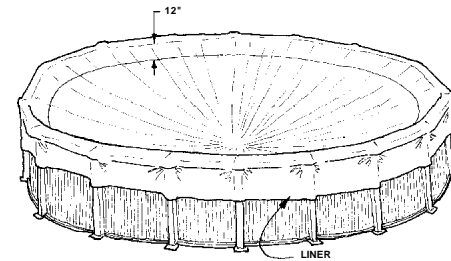

Work in both directions from the point where the liner is overhanging. Unfold liner, drape over the top rail and down the sides approximately 24 inches. The liner should be 6" to 12" above the pool floor in the center ONLY. Remember that the center seam or center section of the liner must be positioned at the center line of the pool. The bottom edge seam of the liner should be inside the pool about 12 inches below the top rails. Correct any bunching or pleating conditions in the liner wall. Inspect liner for open seams. If any are found, return liner to dealer for prompt replacement.

16 FILL POOL

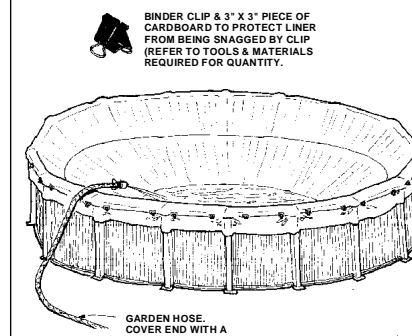

BINDER CLIP & 3" x 3" PIECE OF CARDBOARD TO PROTECT LINER FROM BEING SNAGGED BY CLIP (REFER TO TOOLS & MATERIALS REQUIRED FOR QUANTITY.)
 With the liner in position, hold in place by attaching two binder clips over folded cardboard on the underside of each top rail. Carefully cover the end of a garden hose with a sock and tape securely, place it in the pool and begin to fill. As pool fills, the liner will stretch as the water begins to cover the bottom. At this time, check the sidewall for extreme tautness. **Binder clips do not self-release.** Any area that feels too tight should be relieved by releasing the binder clips and allowing the liner to feed back into the pool until the desired tautness is achieved. Re-clamp binder clips before you proceed around the pool checking and re-clamping. Remember that you are monitoring a minimum tightness of liner over rail that will control the liner seating itself against the pool floor and up the side with no wrinkles. Continue monitoring the liner tension as the water is approaching and covering the cove area of the pool.
 Be sure the liner is evenly distributed over the rail without any bunching or pleating. If this occurs, correct as you are adjusting the liner tension. To correct, grasp the liner wall nearest the wrinkled area. Pull and lift the liner wall just enough to stretch out wrinkles or pleats. It is easier if you wait until there is 1 to 2 inches of water over the wrinkled area before you try to remove it. This allows the weight of the water to hold liner flat on the ground, keeping out wrinkles after you remove them. Pull any excess liner over the rail and re-clamp in position so that a minimum tautness prevents further wrinkling. Double check around the pool so that you have an even tension on the liner wall down to the liner floor. Do not attempt to lift and pull the liner with more than 4 inches of water in the wrinkled area. Damage to the liner may occur.
 When the water is approximately 6 inches up the metal wall and covering the cove, there should be just barely enough tension on the liner to control a virtually wrinkle-free installation.
Filling Deep Excavated Pools (stretch-in liners only): It is important to remember that the floor of the liner (not the liner wall) must stretch into the excavated area. The bottom edge seam should be located in the cove area all the way around the pool when the pool is full of water. Stretch the liner properly or you will end up with the bottom edge seam somewhere on the bottom of the pool and not enough liner wall to go over the steel wall to complete the installation. When this happens, you may think you've received the wrong liner, when in fact the liner was improperly stretched into place.
Cleaning Liner: If you decide to drain the pool to clean the liner, or for any reason, you must leave at least 1 foot (12 inches) of water, measured from ground level up the metal sidewall, in the pool. Failure to comply with this warning may void the warranty.
Liner Replacement: If you decide to replace the liner, you must have the replacement liner at the pool site and ready for immediate installation. DO NOT leave the pool standing without a liner. Do not attempt to install the replacement liner on a windy day. Severe wind damage to your pool may result.

17 CONTINUE FILLING POOL

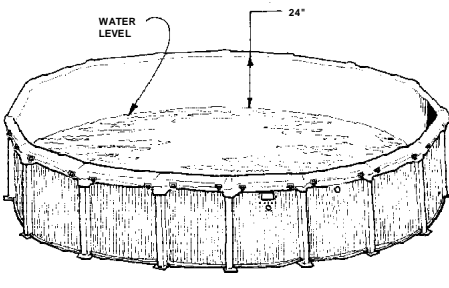

Continue filling pool. **Never allow liner to fall back into pool.** Water between the liner and wall can cause pool failure. When pool has approximately 24 inches of water, stop filling. Do not resume until Steps 18, 19 and 20 are completed. **CAUTION:** Do not cut any openings in liner at this time.

18 PROCEDURE TO ATTACH LINER

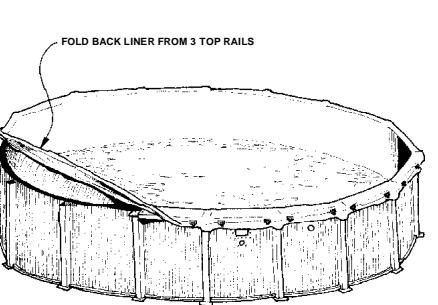

With the help of two or three people, raise and hold the liner up from any three top rail sections. Remove the attaching hardware at the top rail connectors, three top rails, three vertical end caps and stabilizer rails. **REMEMBER, NEVER ALLOW LINER TO FALL BACK INTO POOL.**

19 INSTALL COPING AND STABILIZER RAILS

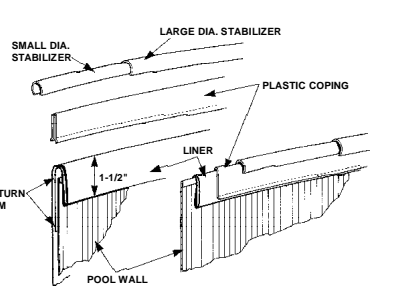

Make a return hem as illustrated. **DO NOT** cut off excess liner material as the liner will "slip" from under the plastic coping, causing liner to fall back into the pool. Smooth liner against wall and secure to top of wall with plastic coping. Place stabilizer rails over coping, alternately telescoping small diameter into large diameter about 6 inches, as before. Replace all parts removed in Step 18. Repeat same steps for entire pool perimeter, working just three top rail sections at a time. **DO NOT allow liner to fall back into pool.**

20 READ ME FIRST FOR POOL SAFETY BOOKLET • WARNINGS • LABELS • SIGNS

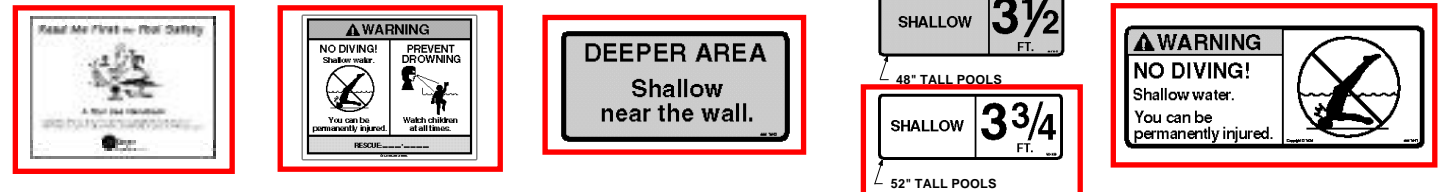

With pool completely assembled, install skimmer, filter, etc. using the instructions provided with those units. Finish filling pool to the correct level as indicated on your skimmer face plate.

Now that you have installed your new pool, Doughboy Recreational would like you to know we are very concerned about your family's safety; so we have provided an assortment of safety literature with your new pool, but it is also a big responsibility. Please take the time to read, and understand all the safety literature provided.

We have also provided you with an assortment of signs and decals. Safety decals and caution information provided with your pool have been endorsed by the U.S. Consumer Product Safety Commission. **It is mandatory that the pool owner and installer follow the installation and use directions for all provided safety signs and decals. We have also provided you with a booklet titled "Read Me First for Pool Safety," which will give you a detailed description of where and how to apply your safety decals and signs. Remember, warnings only help if you put them on. Please help us protect the good health and safety of your family and friends! Read the "Read Me First for Pool Safety" book through completely and follow the directions in it. Don't forget to use a marking pen to write the number of a rescue agency on the signs and on the back of your "Read Me First" booklet. If any of your safety literature, signs or decals become lost or damaged, you can get more free of charge by contacting Doughboy's Customer Service Department. Doughboy Recreational • 315 N. Sebastian St. • West Helena, AR 72390 or calling toll free: (877) 228-4586**

Important! Above-ground pools are designed for swimming and wading only. **Do not Dive or Jump!** Misuse of your pool may result in crippling injury and/or other dangers to life and health. Do not use slides, diving boards, or any other platform or object which can

be used for improper pool entry. Use only an above-ground swimming pool ladder or entry system to enter or exit your pool. Never attempt to swim or reach behind ladders or any other pool entry system. It is the pool owner's responsibility to secure the pool against unauthorized, unsupervised or unintentional entry. It is also the pool owner's responsibility to warn all pool users of the hazards of diving into shallow water; paralyzing injury may result. **Juveniles must be supervised at all times by a responsible adult as directed by the U.S. Consumer Product Safety Commission.** Always obey all safety rules. Remember, pool safety is everybody's responsibility.

Change of Design: Doughboy Recreational expressly reserves the right to change or modify the design and construction of any product in due course of our manufacturing procedures, without incurring any obligation or liability to furnish or install such changes or modifications on products previously or subsequently sold.

